

Technische Änderungen vorbehalten, alle Angaben ohne Gewähr / Subject to technical modifications; no responsibility is accepted for the accuracy of this information. © EUCHNER GmbH + Co. KG Maße in mm / Dimensions in mm

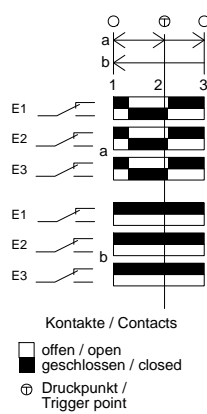

R1
Potentiometer 4.7k lin.
potentiometer 4.7k lin.

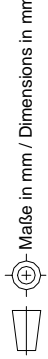
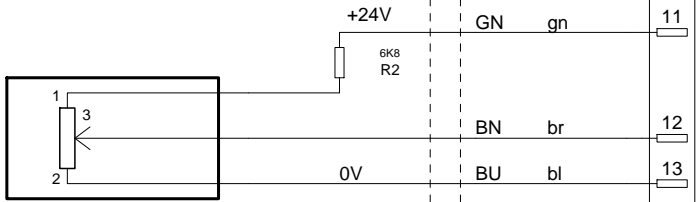

P1
LED gelb
LED yellow

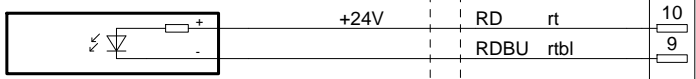

S1
Drucktaste schwarz
push button black

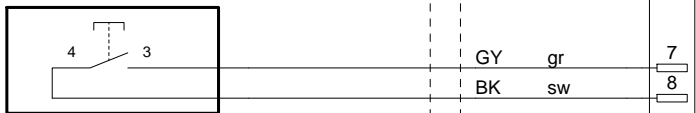

S2
Zustimmtaster
enabling push button

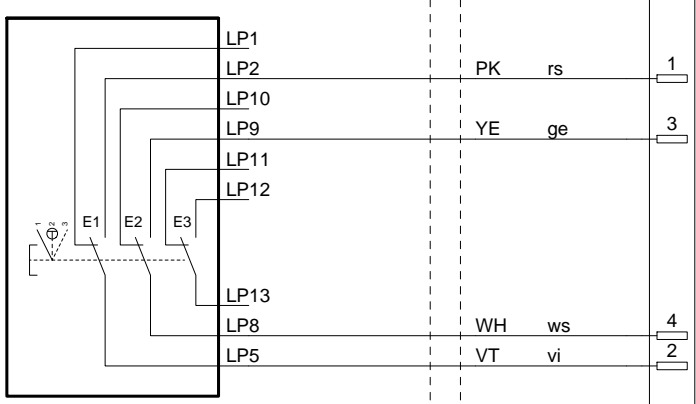

S3
Stufenschalter
2 Stellungen
selector switch
2 positions

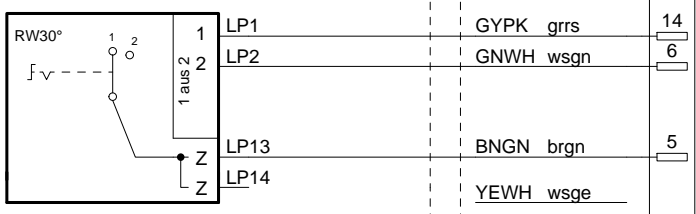

Adern nicht angeschlossen/
wires not connected:

- BNYE gebr
- GYWH wsgr
- BNGY grbr
- WHPK wsrs
- BUWH wsbl
- BNPK rsbr
- BNBU brbl
- RDWH wsrt
- Schirm / shield

Adern/wires: 23x0,14²

Steckverbinder / connector:
Lemo 14-pol FHG Serie 3B