

Technische Änderungen vorbehalten, alle Angaben ohne Gewähr / Subject to technical modifications; no responsibility is accepted for the accuracy of this information. © EUCHNER GmbH + Co. KG

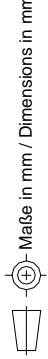

S1	DCBA
1	0000
2	0001
3	0011
4	0010
5	0110
6	0111
7	0101
8	0100
9	1100
10	1101
11	1111
12	1110

S1
Stufenschalter
12 Stellungen
selector switch
12 positions

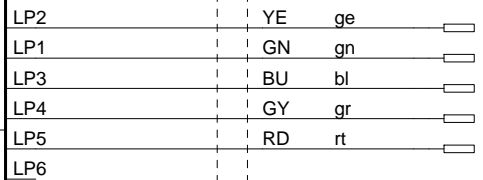
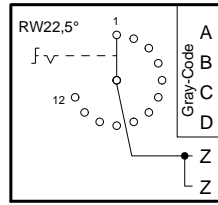

S2 "+"
Drucktaste
push button

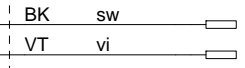
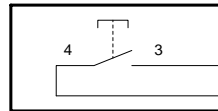

S3 "-"
Drucktaste
push button

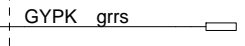
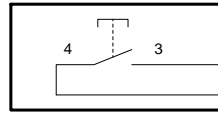

S4
Zustimmtaster
enabling push button

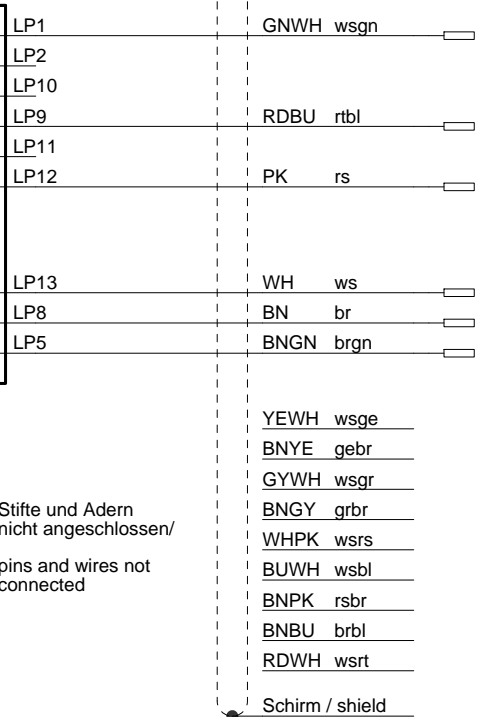
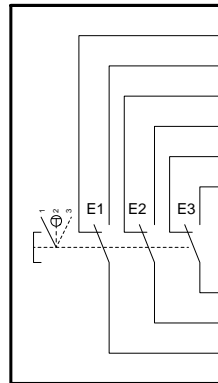
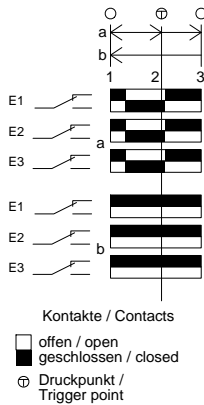

Stifte und Adern
nicht angeschlossen/
pins and wires not
connected

Adern / wires 23x 0,14²
Adern mit Aderendhülsen/
wires with ferrule